

New School - tables technical specification



.mdd

.mdd has a leading position among manufacturers of office furniture with many awards that prove quality and continuously increase demand for it's products.

The realities of today`s market require constant quality improvement at all levels of modern organization. This applies in particular to customer service, marketing, quality of products and also to quality of processes within the company.

Partnership relations among employees and with business partners form a base of economic growth and success of the company.

Constant investments in innovative machinery park, optimization of management systems and an expansion of production halls allow to minimize the lead times for the product of the highest quality.

More than twenty years of experience in office furniture industry come with reference from a long list of companies and institutions to show their appreciation for an efficient and comprehensive service. .mdd is highly aware of the environment.

Being located in the forest region with lake by it's side, .mdd takes the nature seriously and invests constantly in a modern and energy-efficient solutions to preserve the local life. Company puts emphasis on waste segregation and recycling. .mdd has been awarded for the exceptional care and involvement in waste disposal. All materials used are environmentally friendly and enjoy a high 95 % rate of being recycled.



General informations:

Warranty:

.mdd products - **5 years.**

Electrical components and fabric - **2 years.**

Certificate - MFC:



Certificate - linoleum:



Assembly:

the product comes pre-assembled

Packing:

cardboard

New School - tables	Date of preparation 24.06.2022	The data contained in this document is valid in the day of its preparation. Change of the product, as long as it does not affect the basic features of it, does not require consistent updates of the document.	page 2/6 general informations
---------------------	-----------------------------------	---	---

Technical specification

1. **Top** - 19 mm MDF board; covered in bacteriostatic linoleum with resistance to finger prints; varnished Edge
2. **Frame** - metal, powder coated, frame made of tube Ø25 mm
3. **Leveling feet** - range 9 mm

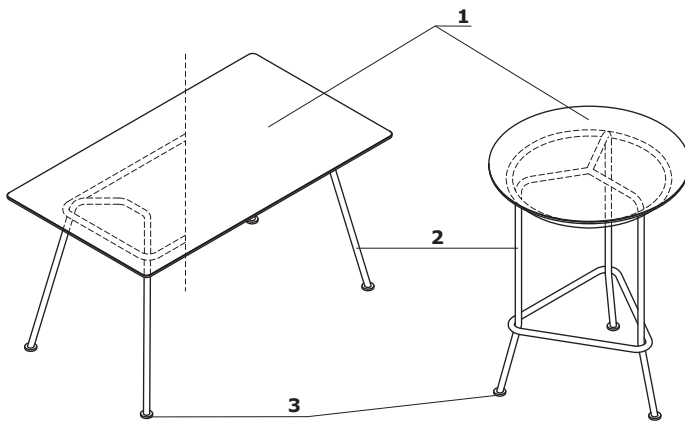

Top edging always matching the colour of the framework.

New School - tables *



NS812
1200 / 800 / 750
33.1 kg



NS814
1400 / 800 / 750
33.5 kg

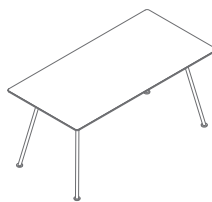

NS816
1600 / 800 / 750
36.6 kg

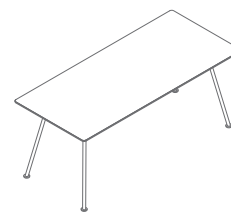

NS818
1800 / 800 / 750
40.3 kg



NS77
700 / 700 / 750
19.8 kg



NS88
800 / 800 / 750
25.3 kg



NS11
1000 / 1000 / 750
31 kg



NS70
700 / 700 / 750
15.5 kg



NS80
800 / 800 / 750
17 kg



NS100
1000 / 1000 / 750
26.5 kg

New School - high tables *



NS80H
800 / 800 / 1050
22 kg



NS100H
1000 / 1000 / 1050
31.7 kg

* dimensions expressed in millimeters: width x depth x height

New School - high tables *



NS88H
800 / 800 / 1050
30.5 kg



NS11H
1000 / 1000 / 1050
37.5 kg



NS812H
1200 / 800 / 1050
39.5 kg



NS814H
1400 / 800 / 1050
40.5 kg



NS816H
1600 / 800 / 1050
43.8 kg

New School - meeting tables *

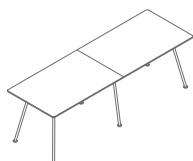

NS824
2400 / 800 / 750
61.9 kg

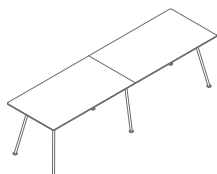

NS828
2800 / 800 / 750
62.7 kg

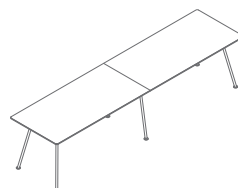

NS832
3200 / 800 / 750
69.1 kg

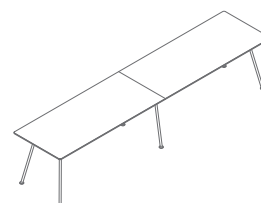

NS836
3600 / 800 / 750
76.1 kg

* dimensions expressed in millimeters: width x depth x height

Worktop - Linoleum



Light grey



Dark green



Burgundy



Black



Blue

Frame - metal



M012 Dark green
semi-matt RAL6012



M013 Burgundy
semi-matt RAL3007



M115 Black
semi-matt RAL9005



M010 Light grey
semi-matt RAL7044



M027 Blue
semi-matt RAL5003

