

HAMPTON FABRIC

Mod.441

SOLO MODULES

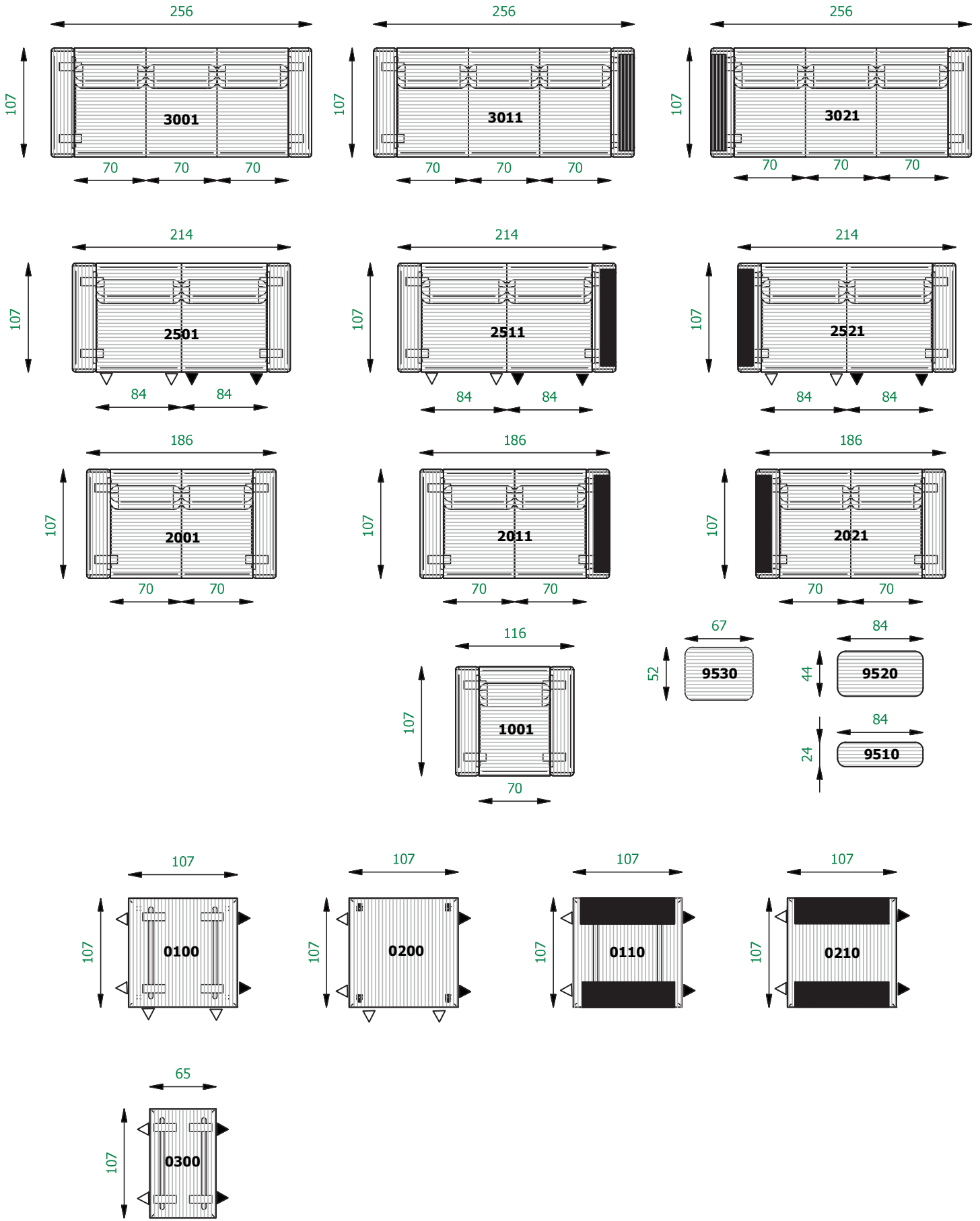

BUILDING MODULES

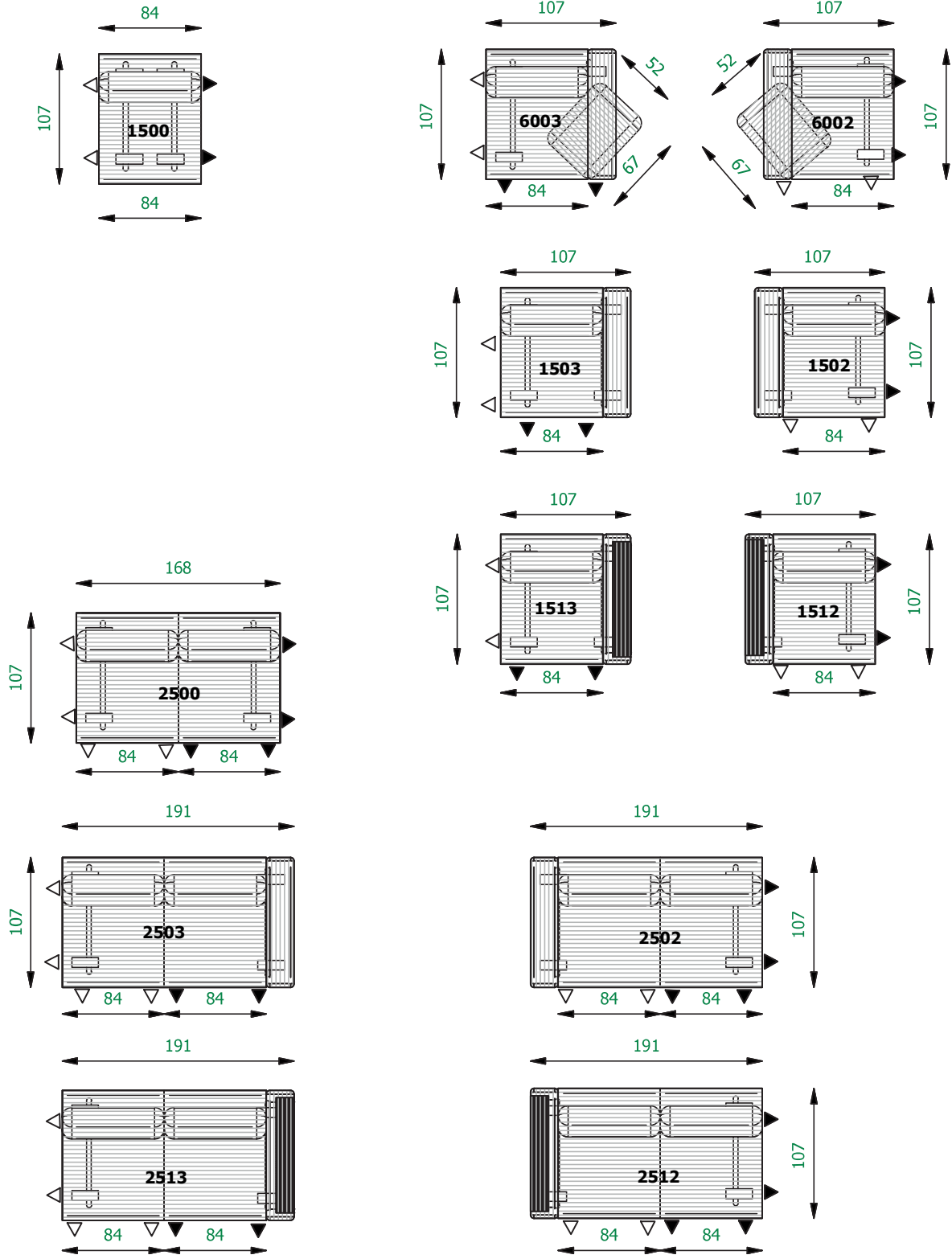

DIRECTION OF PATTERN

CONNECTORS

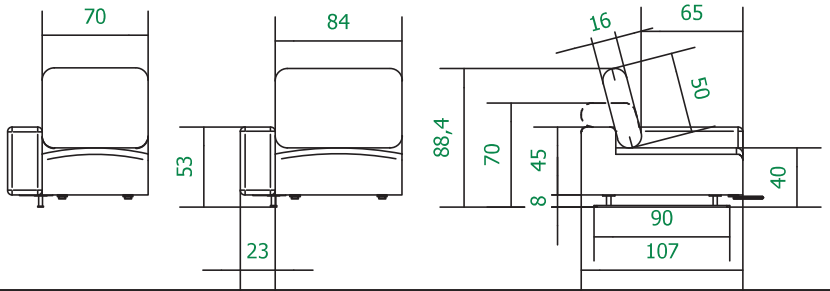
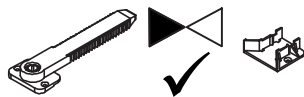
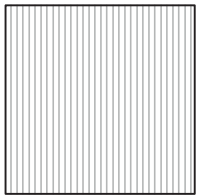

LEGS/ACCESSORIES: INCLUDED

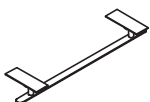

8x90x22/4cm

Ø6x8cm

SE MORE DESIGNS ON www.BOCONCEPT.com

BoConcept
Urban Danish Design

HAMPTON LEATHER

Mod.441

SOLO MODULES

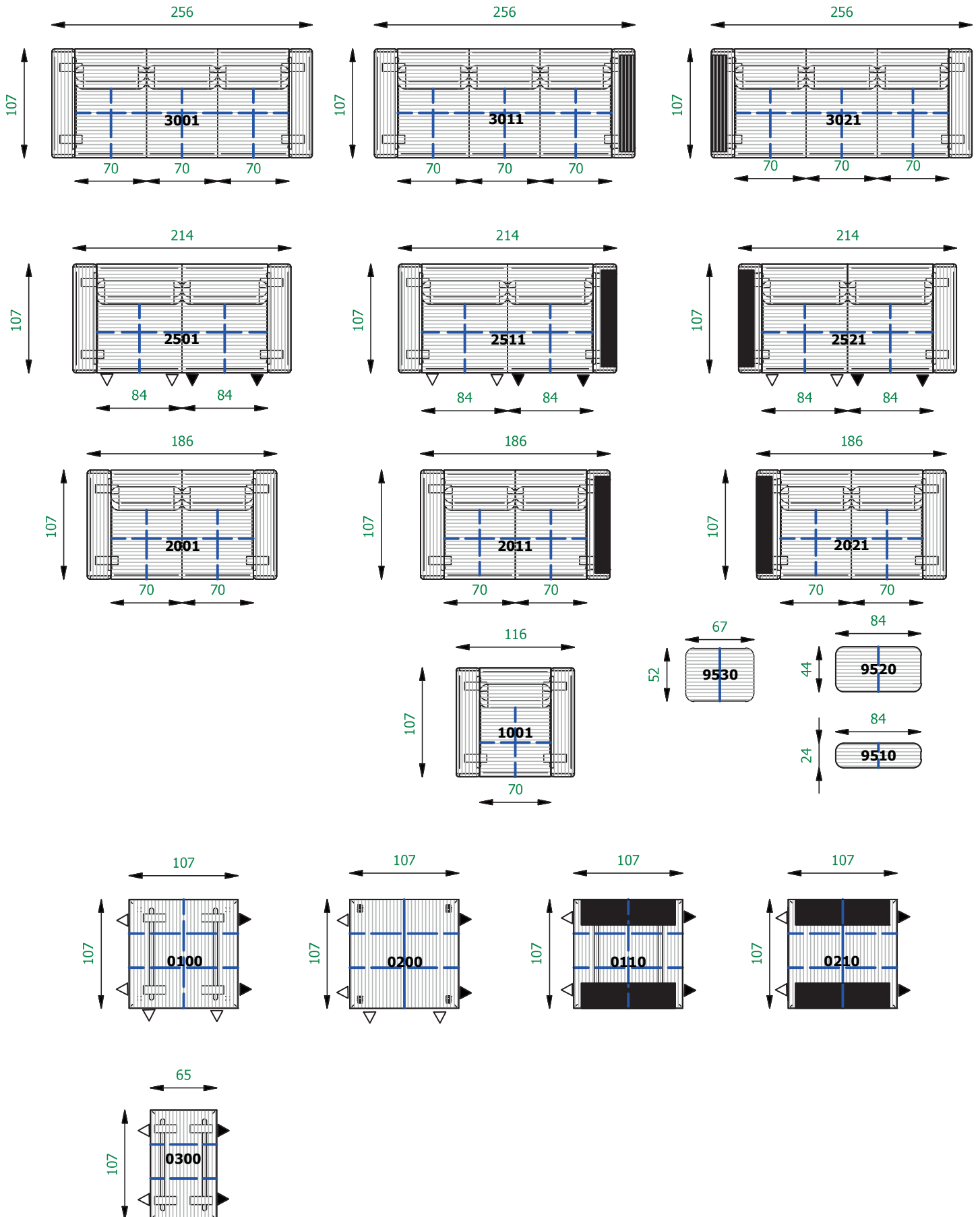

BUILDING MODULES

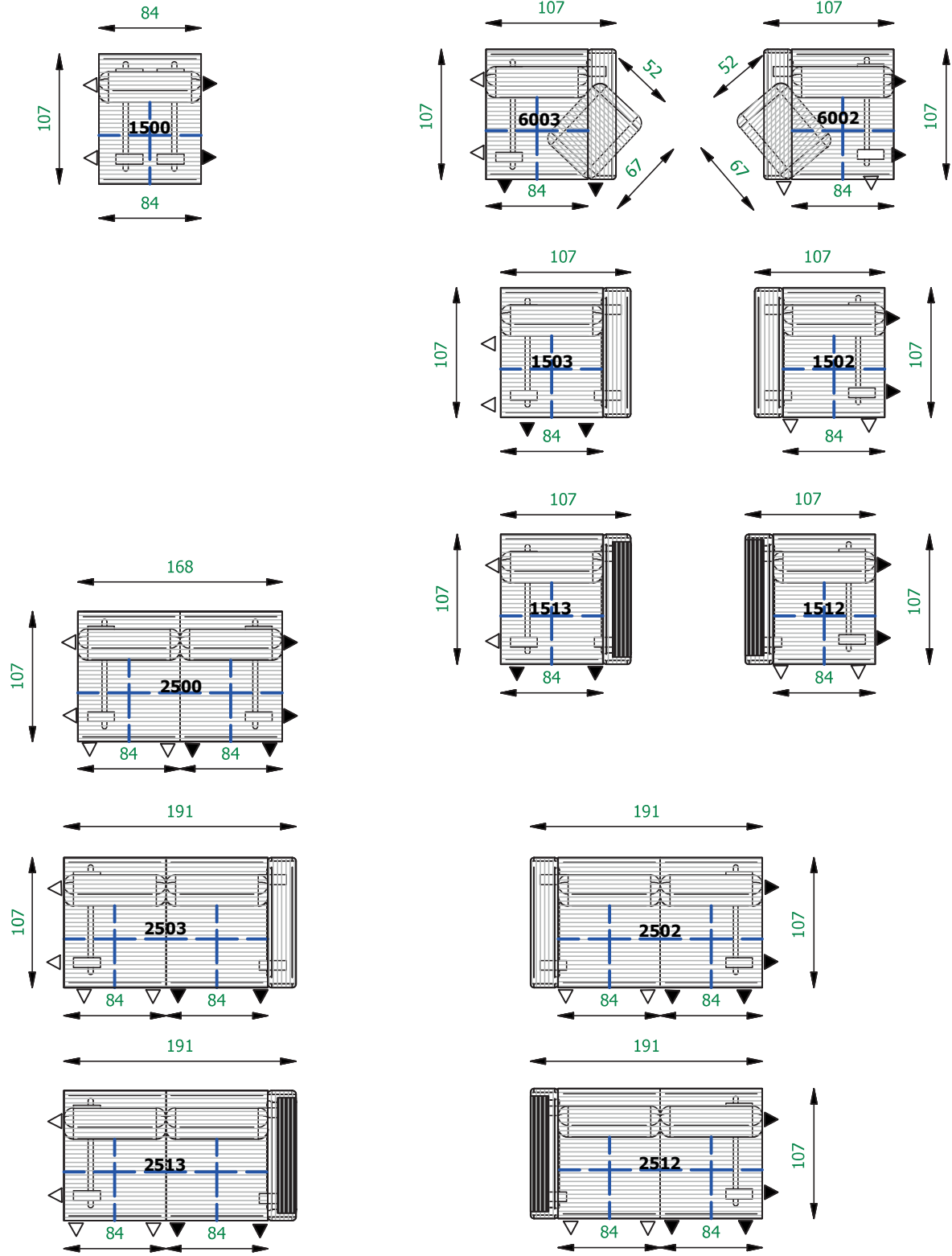

DIRECTION OF PATTERN

CONNECTORS

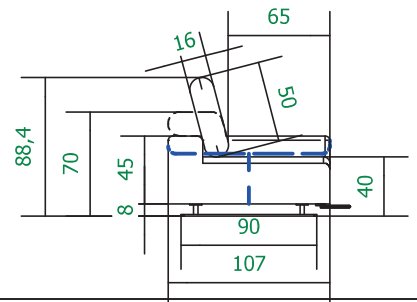
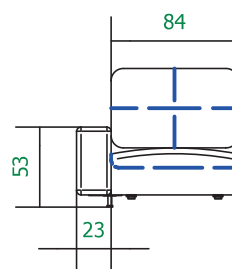
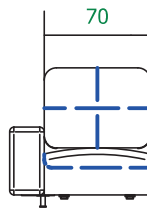
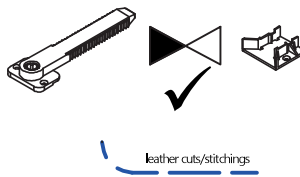
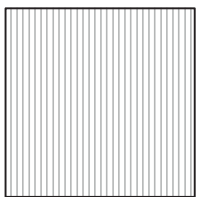

LEGS/ACCESSORIES: INCLUDED

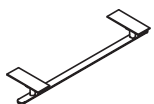

8x90x22/4cm



Ø6x8cm

SE MORE DESIGNS ON www.BOCONCEPT.com

BoConcept
Urban Danish Design